

ha 2000

- 1 = 7503 1000
- 1 = 7504 1000
- 2 = 7503 1001
- 3 = 7501 7000 230/50
- 3 = 7502 7000 400/50
- 4 = 7501 7100 230/50
- 4 = 7502 7100 400/50
- 5 = 7501 2300
- 5 = 7502 3300
- 6 = 0209 3364
- 7 = 0290 2108

- 11 = 7503 1004
- 12 = 7503 1006
- 13 = 0109 8820
- 14 = 0500 7803
- 15 = 0273 4903
- 16 = 7503 1200
- 16 = 7503 1200
- 17 = 7503 1003
- 18 = 0500 8403

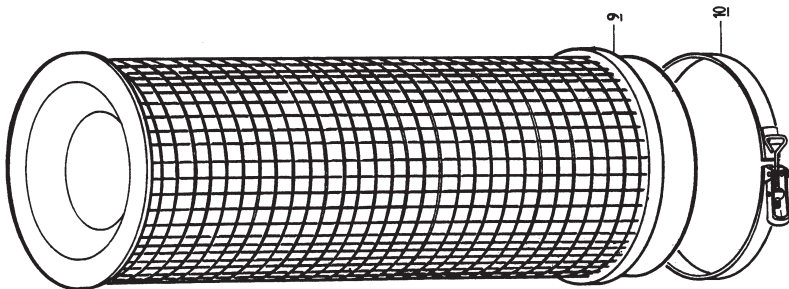
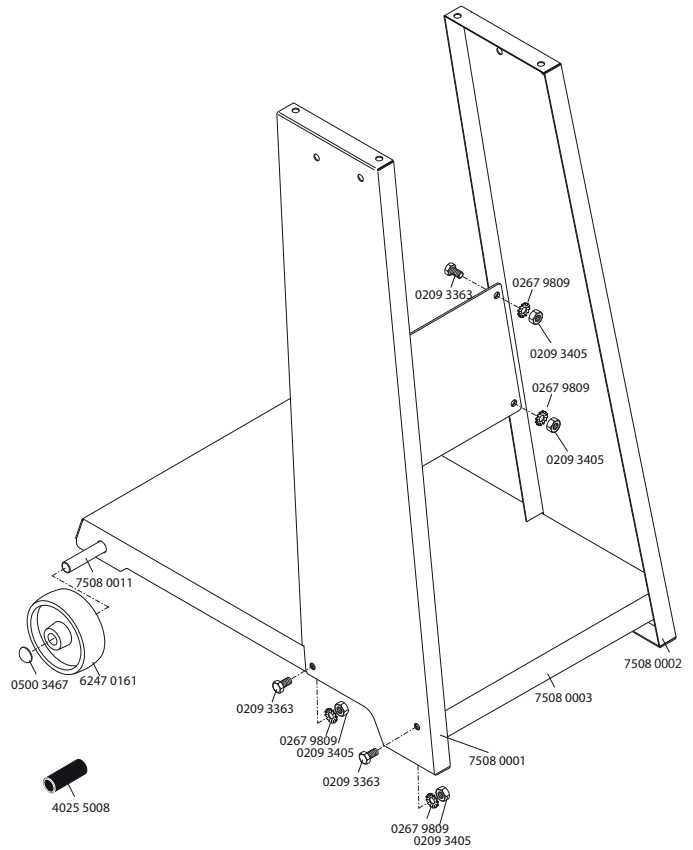
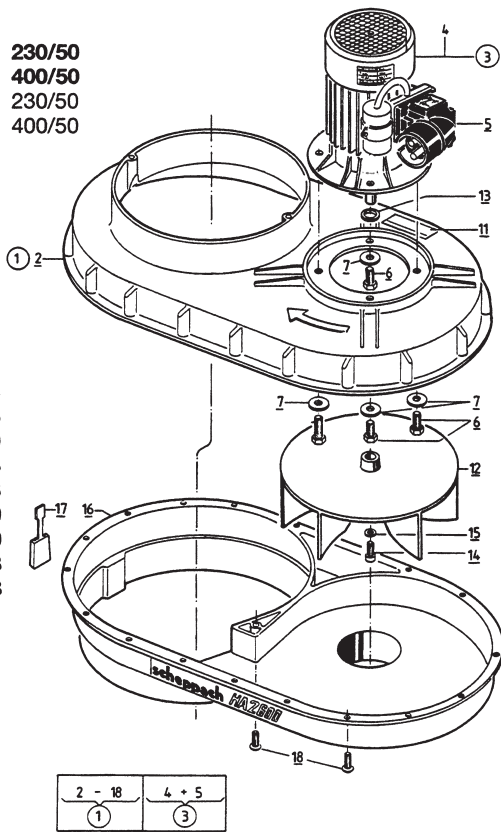

- 10 = 7500 6002
- 13 = 7520 5300
- 14 = 7520 5302
- 15 = 0500 5401
- 16 = 7520 5205
- 17 = 0267 9806
- 18 = 0209 3404
- 19 = 7520 5206
- 20 = 7520 5100

- 1 = 7503 2007
- 2 = 7500 1019
- 3 = 7508 0009
- 4 = 7508 0008
- 5 = 7500 1021
- 6 = 7500 1017
- 7 = 7508 0007
- 8 = 7500 1415
- 9 = 7500 6001

